

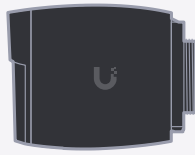

AI Professional



1x

a



1x

b



2x

c

M4



2x

d



1x

e

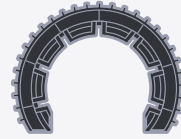

1x

f



1x

g

M4



2x

h



A

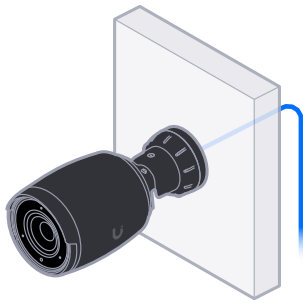

B

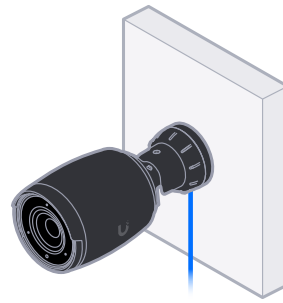

C



D



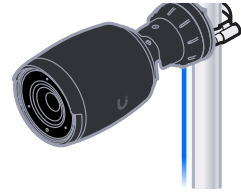
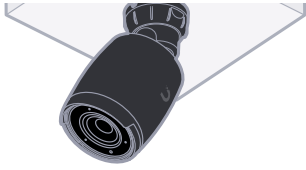

E

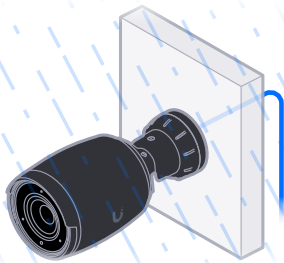

F

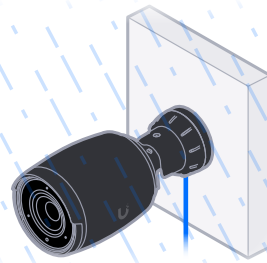

G

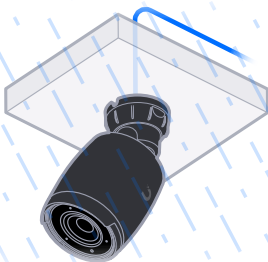

H

